

LP2992

Micropower 250 mA Low-Noise Ultra Low-Dropout Regulator in SOT-23 and LLP Packages

Designed for Use with Very Low ESR Output Capacitors

General Description

The LP2992 is a 250 mA, fixed-output voltage regulator designed to provide ultra low-dropout and low noise in battery powered applications.

Using an optimized VIP™ (Vertically Integrated PNP) process, the LP2992 delivers unequalled performance in all specifications critical to battery-powered designs:

Dropout Voltage: Typically 450 mV @ 250 mA load, and 5 mV @ 1 mA load.

Ground Pin Current: Typically 1500 µA @ 250 mA load, and 75 µA @ 1 mA load.

Enhanced Stability: The LP2992 is stable with output capacitor ESR as low as 5 mΩ, which allows the use of ceramic capacitors on the output.

Sleep Mode: Less than 1 µA quiescent current when ON/OFF pin is pulled low.

Smallest Possible Size: SOT-23 and LLP packages use absolute minimum board space.

Precision Output: 1% tolerance output voltages available (A grade).

Low Noise: By adding a 10 nF bypass capacitor, output noise can be reduced to 30 µV (typical).

Multiple voltage options, from 1.5V to 5.0V, are available as standard products. Consult factory for custom voltages.

Features

- Ultra low dropout voltage
- Guaranteed 250 mA output current
- Smallest possible size (SOT-23, LLP package)
- Requires minimum external components
- Stable with low-ESR output capacitor
- <1 µA quiescent current when shut down
- Low ground pin current at all loads
- Output voltage accuracy 1% (A Grade)
- High peak current capability
- Wide supply voltage range (16V max)
- Low Z_{OUT}: 0.3Ω typical (10 Hz to 1 MHz)
- Overtemperature/overcurrent protection
- -40°C to +125°C junction temperature range
- Custom voltages available

Applications

- Cellular Phone
- Palmtop/Laptop Computer
- Personal Digital Assistant (PDA)
- Camcorder, Personal Stereo, Camera

Block Diagram

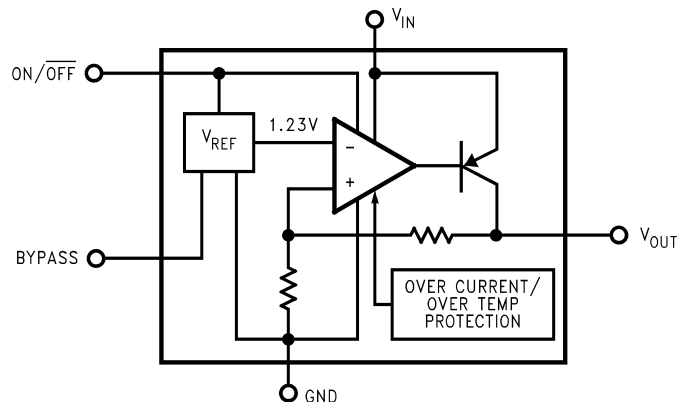

20029401

VIP™ is a trademark of National Semiconductor Corporation.

Basic Application Circuit

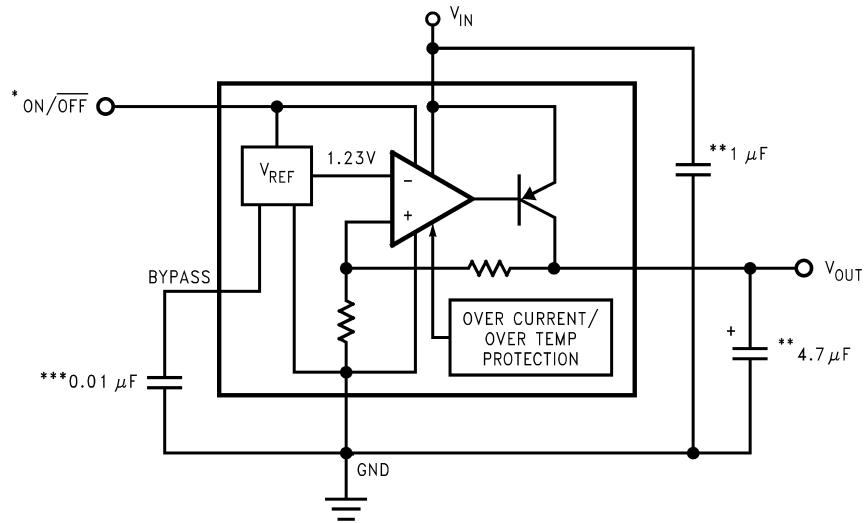

20029402

*ON/OFF input must be actively terminated. Tie to V_{IN} if this function is not to be used.

**Minimum capacitance is shown to ensure stability (may be increased without limit). Ceramic capacitor required for output (see Application Hints).

***Reduces output noise (may be omitted if application is not noise critical). Use ceramic or film type with very low leakage current (see Application Hints).

Connection Diagrams

5-Lead Small Outline Package (M5)

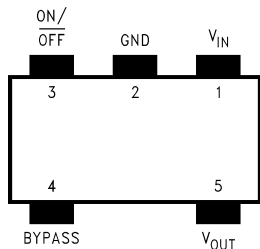

20029403

Top View

See NS Package Number MF05A
For ordering information see Table 1

6-Lead LLP Package (LD)

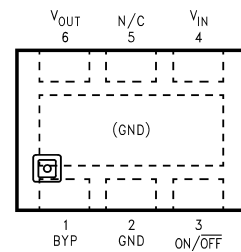

20029446

Top View

See NS Package Number NLDBA006
Outline Drawing LDE06A

Ordering Information

TABLE 1. Package Marking and Ordering Information

Output Voltage (V)	Grade	Order Information	Package Marking	Supplied as:
5-Lead Small Outline Package (M5)				
1.5	A	LP2992AIM5X-1.5	LFBA	3000 Units on Tape and Reel
1.5	A	LP2992AIM5-1.5	LFBA	1000 Units on Tape and Reel
1.5	STD	LP2992IM5X-1.5	LFBB	3000 Units on Tape and Reel
1.5	STD	LP2992IM5-1.5	LFBB	1000 Units on Tape and Reel
1.8	A	LP2992AIM5X-1.8	LFCA	3000 Units on Tape and Reel
1.8	A	LP2992AIM5-1.8	LFCA	1000 Units on Tape and Reel
1.8	STD	LP2992IM5X-1.8	LFCB	3000 Units on Tape and Reel
1.8	STD	LP2992IM5-1.8	LFCB	1000 Units on Tape and Reel
2.5	A	LP2992AIM5X-2.5	LFDA	3000 Units on Tape and Reel
2.5	A	LP2992AIM5-2.5	LFDA	1000 Units on Tape and Reel
2.5	STD	LP2992IM5X-2.5	LFDB	3000 Units on Tape and Reel
2.5	STD	LP2992IM5-2.5	LFDB	1000 Units on Tape and Reel
3.0	A	LP2992AIM5X-3.0	LF8A	3000 Units on Tape and Reel
3.0	A	LP2992AIM5-3.0	LF8A	1000 Units on Tape and Reel
3.0	STD	LP2992IM5X-3.0	LF8B	3000 Units on Tape and Reel
3.0	STD	LP2992IM5-3.0	LF8B	1000 Units on Tape and Reel
3.3	A	LP2992AIM5X-3.3	LFEA	3000 Units on Tape and Reel
3.3	A	LP2992AIM5-3.3	LFEA	1000 Units on Tape and Reel
3.3	STD	LP2992IM5X-3.3	LFEB	3000 Units on Tape and Reel
3.3	STD	LP2992IM5-3.3	LFEB	1000 Units on Tape and Reel
5.0	A	LP2992AIM5X-5.0	LFFA	3000 Units on Tape and Reel
5.0	A	LP2992AIM5-5.0	LFFA	1000 Units on Tape and Reel
5.0	STD	LP2992IM5X-5.0	LFFB	3000 Units on Tape and Reel
5.0	STD	LP2992IM5-5.0	LFFB	1000 Units on Tape and Reel
6-Lead LLP Package (LDE06A)				
1.5	A	LP2992AILDX-1.5	L011A	4500 Units on Tape and Reel
1.5	A	LP2992AILD-1.5	L011A	1000 Units on Tape and Reel
1.5	STD	LP2992ILD-1.5	L011AB	4500 Units on Tape and Reel
1.5	STD	LP2992ILD-1.5	L011AB	1000 Units on Tape and Reel
1.8	A	LP2992AILDX-1.8	L012A	4500 Units on Tape and Reel
1.8	A	LP2992AILD-1.8	L012A	1000 Units on Tape and Reel
1.8	STD	LP2992ILD-1.8	L012AB	4500 Units on Tape and Reel
1.8	STD	LP2992ILD-1.8	L012AB	1000 Units on Tape and Reel
2.5	A	LP2992AILDX-2.5	L013A	4500 Units on Tape and Reel
2.5	A	LP2992AILD-2.5	L013A	1000 Units on Tape and Reel
2.5	STD	LP2992ILD-2.5	L013AB	4500 Units on Tape and Reel
2.5	STD	LP2992ILD-2.5	L013AB	1000 Units on Tape and Reel
3.3	A	LP2992AILDX-3.3	L014A	4500 Units on Tape and Reel
3.3	A	LP2992AILD-3.3	L014A	1000 Units on Tape and Reel
3.3	STD	LP2992ILD-3.3	L014AB	4500 Units on Tape and Reel
3.3	STD	LP2992ILD-3.3	L014AB	1000 Units on Tape and Reel
5.0	A	LP2992AILDX-5.0	L015A	4500 Units on Tape and Reel
5.0	A	LP2992AILD-5.0	L015A	1000 Units on Tape and Reel
5.0	STD	LP2992ILD-5.0	L015AB	4500 Units on Tape and Reel
5.0	STD	LP2992ILD-5.0	L015AB	1000 Units on Tape and Reel

Absolute Maximum Ratings (Note 1)

If Military/Aerospace specified devices are required, please contact the National Semiconductor Sales Office/Distributors for availability and specifications.

Storage Temperature Range	-65°C to +150°C
Operating Junction Temperature Range	-40°C to +125°C
Lead Temp. (Soldering, 5 sec.)	260°C
ESD Rating (Note 2)	2 kV
Power Dissipation (Note 3)	Internally Limited

Input Supply Voltage (Survival)	-0.3V to +16V
Input Supply Voltage (Operating)	2.2V to +16V
Shutdown Input Voltage (Survival)	-0.3V to +16V
Output Voltage (Survival, (Note 4))	-0.3V to +9V
I _{OUT} (Survival)	Short Circuit Protected
Input-Output Voltage (Survival, (Note 5))	-0.3V to +16V

Electrical Characteristics

Limits in standard typeface are for T_J = 25°C. and limits in **boldface type** apply over the full operating temperature range. Unless otherwise specified: V_{IN} = V_O(NOM) + 1V, I_L = 1 mA, C_{IN} = 1 μF, C_{OUT} = 4.7 μF, V_{ON/OFF} = 2V.

Symbol	Parameter	Conditions	Typ	LP2992AI-X.X (Note 6)		LP2992I-X.X (Note 6)		Units
				Min	Max	Min	Max	
ΔV _O	Output Voltage Tolerance	I _L = 1 mA		-1.0	1.0	-1.5	1.5	%V _{NOM}
		1 mA ≤ I _L ≤ 50 mA		-1.5	1.5	-2.5	2.5	
		1 mA ≤ I _L ≤ 250 mA		-3.5	3.5	-4.0	4.0	
$\frac{\Delta V_O}{\Delta V_{IN}}$	Output Voltage	V _O (NOM)+1V ≤ V _{IN} ≤ 16V	0.007		0.014		0.014	%V
	Line Regulation				0.032		0.032	
V _{IN} (min)	Minimum input voltage required to maintain output regulation		2.05		2.20		2.20	V
V _{IN} -V _O	Dropout Voltage (Note 7)	I _L = 0	0.5		2.5		2.5	mV
		I _L = 1 mA	5		9		9	
		I _L = 50 mA	100		125		125	
		I _L = 150 mA	260		325		325	
		I _L = 250 mA	450		575		575	
I _{GND}	Ground Pin Current	I _L = 0	65		95		95	μA
		I _L = 1 mA	75		110		110	
		I _L = 50 mA	350		600		600	
		I _L = 150 mA	850		1500		1500	
		I _L = 250 mA	1500		2300		2300	
		V _{ON/OFF} < 0.3V	0.01		0.8		0.8	
		V _{ON/OFF} < 0.15V	0.05		2		2	
V _{ON/OFF}	ON/OFF Input Voltage (Note 8)	High = O/P ON	1.4	1.6		1.6		V
		Low = O/P OFF	0.55		0.15		0.15	

Electrical Characteristics (Continued)

Limits in standard typeface are for $T_J = 25^\circ\text{C}$, and limits in **boldface type** apply over the full operating temperature range. Unless otherwise specified: $V_{IN} = V_O(\text{NOM}) + 1\text{V}$, $I_L = 1\text{ mA}$, $C_{IN} = 1\ \mu\text{F}$, $C_{OUT} = 4.7\ \mu\text{F}$, $V_{ON/OFF} = 2\text{V}$.

Symbol	Parameter	Conditions	Typ	LP2992AI-X.X (Note 6)		LP2992I-X.X (Note 6)		Units
				Min	Max	Min	Max	
$I_{ON/OFF}$	ON/OFF Input Current	$V_{ON/OFF} = 0$	0.01		-2		-2	μA
		$V_{ON/OFF} = 5\text{V}$	5		15		15	
e_n	Output Noise Voltage (RMS)	$BW = 300\text{ Hz to }50\text{ kHz}$, $C_{OUT} = 10\ \mu\text{F}$ $C_{BYPASS} = 10\ \text{nF}$	30					μV
$\frac{\Delta V_{OUT}}{\Delta V_{IN}}$	Ripple Rejection	$f = 1\text{ kHz}$, $C_{BYPASS} = 10\ \text{nF}$ $C_{OUT} = 10\ \mu\text{F}$	45					dB
$I_{O(SC)}$	Short Circuit Current	$R_L = 0$ (Steady State) (Note 9)	400					mA
$I_{O(PK)}$	Peak Output Current	$V_{OUT} \geq V_o(\text{NOM}) - 5\%$	350					mA

Note 1: "Absolute Maximum Ratings" indicate limits beyond which damage to the component may occur. Electrical specifications do not apply when operating the device outside of its rated operating conditions.

Note 2: The ESD rating of pins 3 and 4 for the SOT-23 package, or pins 1 and 3 for the LLP package, is 1 kV.

Note 3: The maximum allowable power dissipation is a function of the maximum junction temperature, $T_J(\text{MAX})$, the junction-to-ambient thermal resistance, θ_{J-A} , and the ambient temperature, T_A . The maximum allowable power dissipation at any ambient temperature is calculated using:

$$P(\text{MAX}) = \frac{T_J(\text{MAX}) - T_A}{\theta_{J-A}}$$

Where the value of θ_{J-A} for the SOT-23 package is 220°C/W in a typical PC board mounting and the LLP package is 65°C/W . Exceeding the maximum allowable dissipation will cause excessive die temperature, and the regulator will go into thermal shutdown.

Note 4: If used in a dual-supply system where the regulator load is returned to a negative supply, the LP2992 output must be diode-clamped to ground.

Note 5: The output PNP structure contains a diode between the V_{IN} to V_{OUT} terminals that is normally reverse-biased. Reversing the polarity from V_{IN} to V_{OUT} will turn on this diode.

Note 6: Limits are 100% production tested at 25°C . Limits over the operating temperature range are guaranteed through correlation using Statistical Quality Control (SQC) methods. The limits are used to calculate National's Average Outgoing Quality Level (AOQL).

Note 7: V_{IN} must be the greater of 2.2V or $V_{OUT(\text{nom})} + \text{Dropout Voltage}$ to maintain output regulation. Dropout voltage is defined as the input to output differential at which the output voltage drops 2% below the value measured with a 1V differential.

Note 8: The ON/OFF input must be properly driven to prevent possible misoperation. For details, refer to Application Hints.

Note 9: The LP2992 has foldback current limiting which allows a high peak current when $V_{OUT} > 0.5\text{V}$, and then reduces the maximum output current as V_{OUT} is forced to ground (see Typical Performance Characteristics curves).

Typical Performance Characteristics Unless otherwise specified: $C_{IN} = 1\mu F$, $C_{OUT} = 4.7\mu F$, $V_{IN} = V_{OUT(NOM)} + 1$, $T_A = 25^\circ C$, ON/OFF pin is tied to V_{IN} .

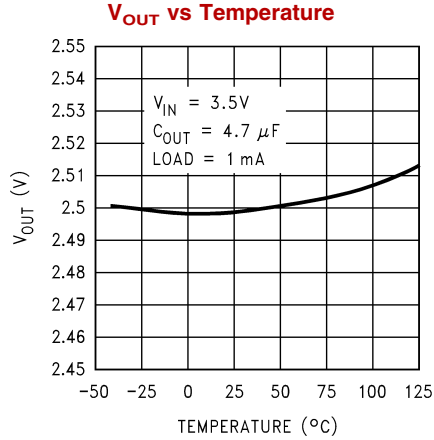

20029408

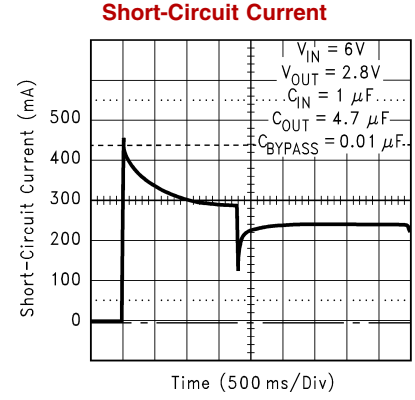

20029409

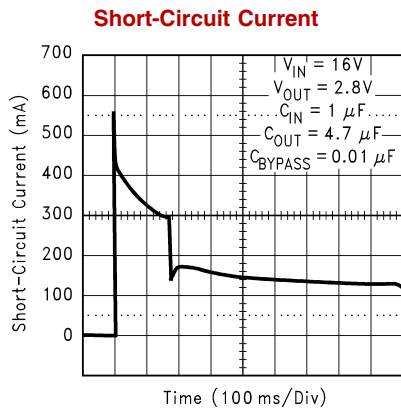

20029410

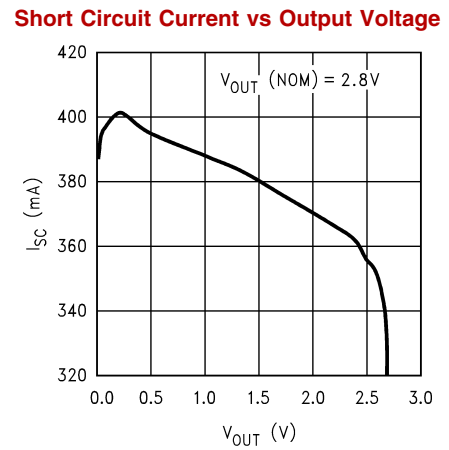

20029411

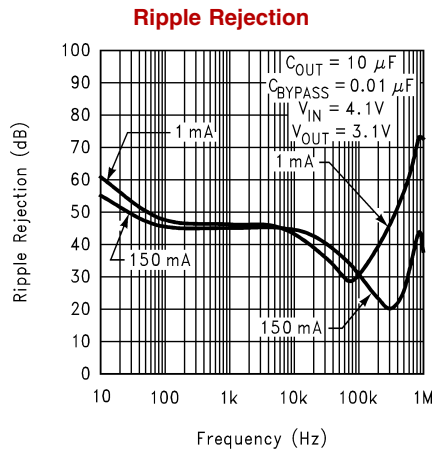

20029413

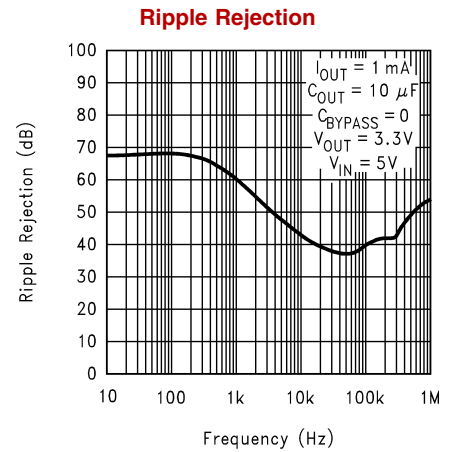

20029414

Typical Performance Characteristics Unless otherwise specified: $C_{IN} = 1\mu\text{F}$, $C_{OUT} = 4.7\mu\text{F}$, $V_{IN} = V_{OUT(NOM)} + 1$, $T_A = 25^\circ\text{C}$, ON/OFF pin is tied to V_{IN} . (Continued)

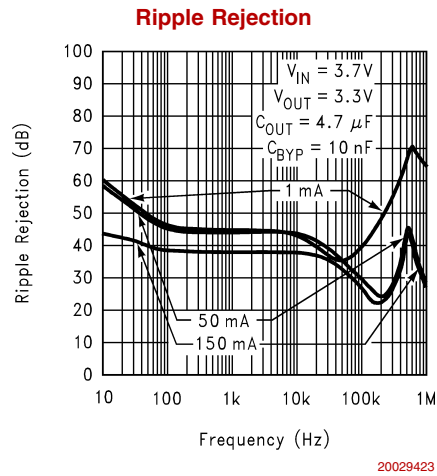
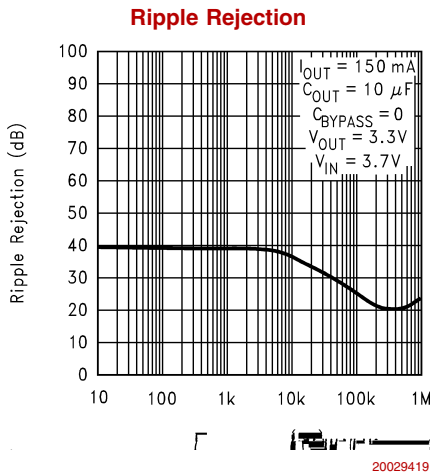
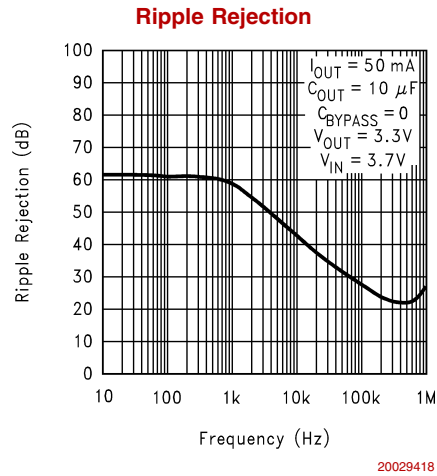
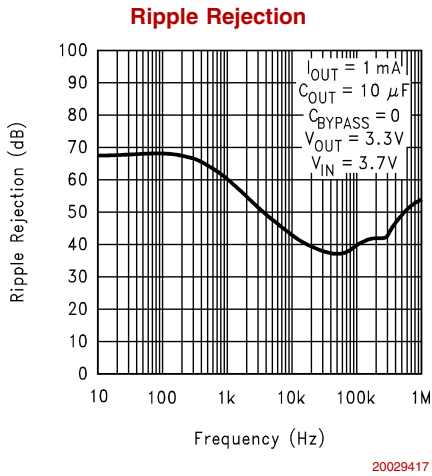
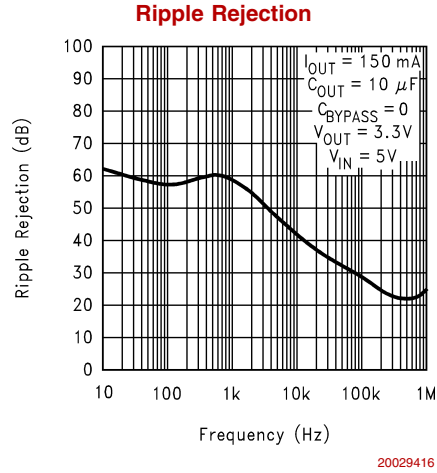
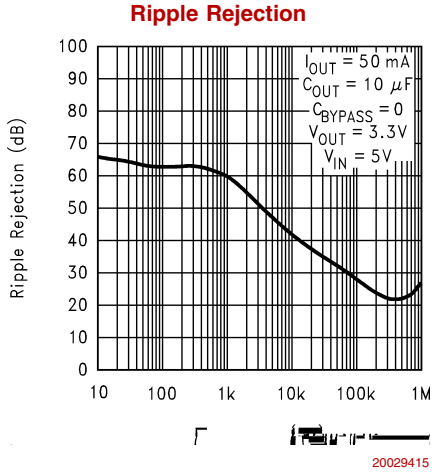

Typical Performance Characteristics Unless otherwise specified: $C_{IN} = 1\mu F$, $C_{OUT} = 4.7\mu F$, $V_{IN} = V_{OUT(NOM)} + 1$, $T_A = 25^\circ C$, ON/OFF pin is tied to V_{IN} . (Continued)

Ripple Rejection

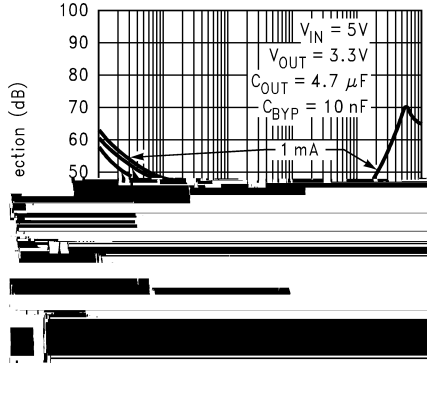

20029422

Output Impedance vs Frequency

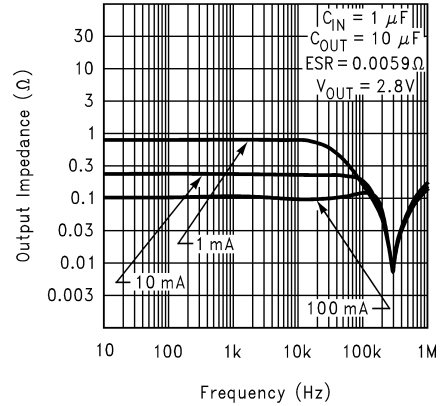

20029420

Output Impedance vs Frequency

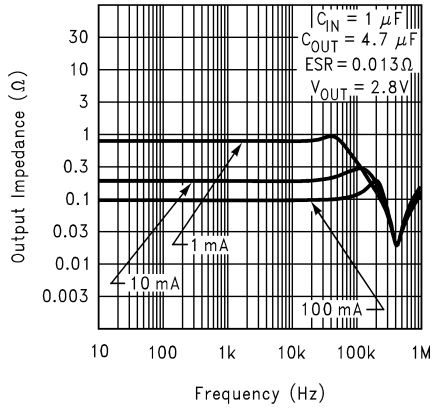

20029421

Output Noise Density

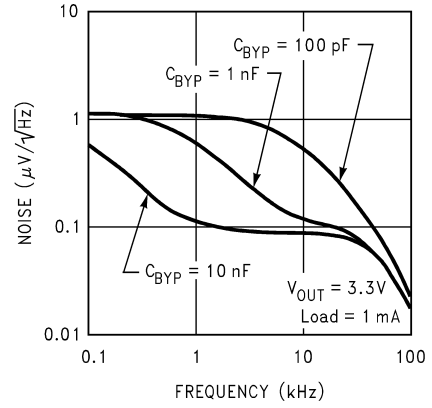

20029424

Output Noise Density

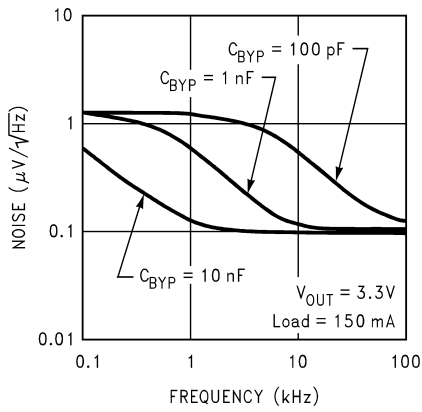

20029425

GND Pin vs Load Current

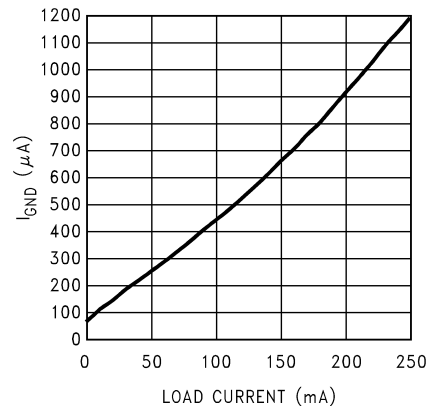

20029426

Typical Performance Characteristics Unless otherwise specified: $C_{IN} = 1\mu F$, $C_{OUT} = 4.7\mu F$, $V_{IN} = V_{OUT(NOM)} + 1$, $T_A = 25^\circ C$, ON/OFF pin is tied to V_{IN} . (Continued)

Dropout Voltage vs Temperature

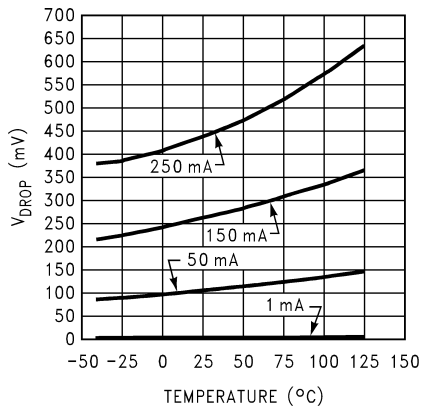

20029427

Input Current vs Pin

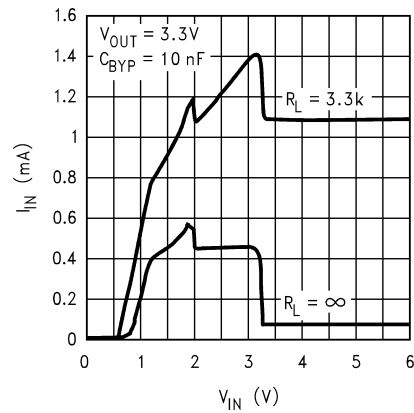

20029429

I_{GND} vs Load and Temperature

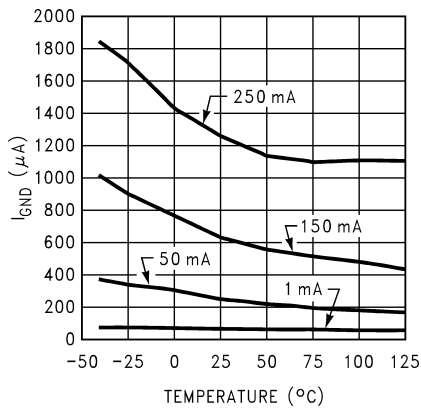

20029430

Instantaneous Short Circuit Current

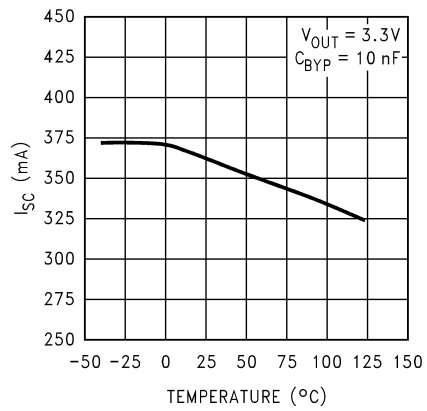

20029431

Load Transient Response

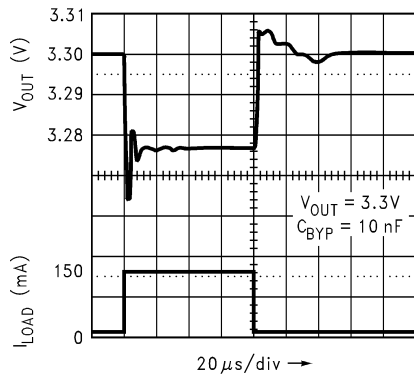

20029433

Load Transient Response

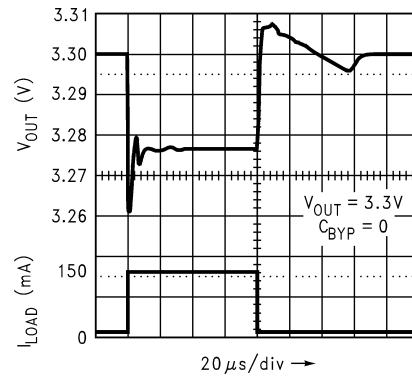

20029434

Typical Performance Characteristics Unless otherwise specified: $C_{IN} = 1\mu F$, $C_{OUT} = 4.7\mu F$, $V_{IN} = V_{OUT(NOM)} + 1$, $T_A = 25^\circ C$, ON/OFF pin is tied to V_{IN} . (Continued)

Load Transient Response

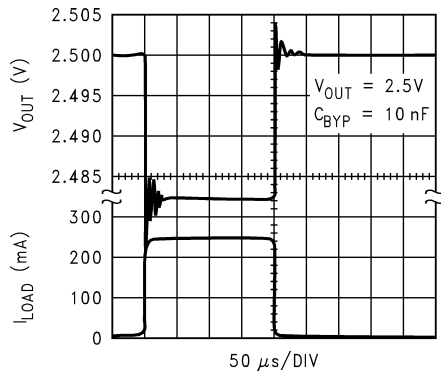

20029447

Line Transient Response

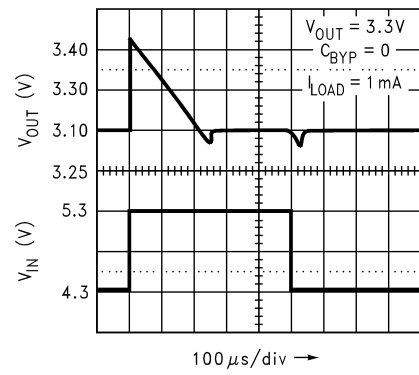

20029435

Line Transient Response

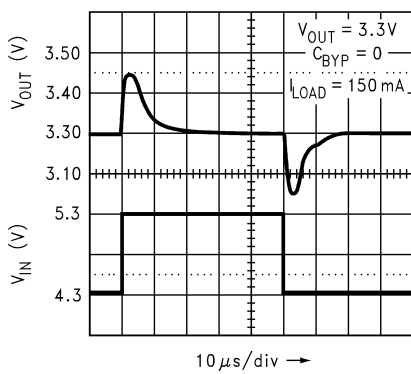

20029436

Line Transient Response

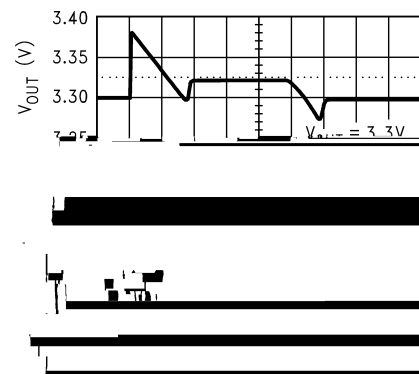

20029437

Line Transient Response

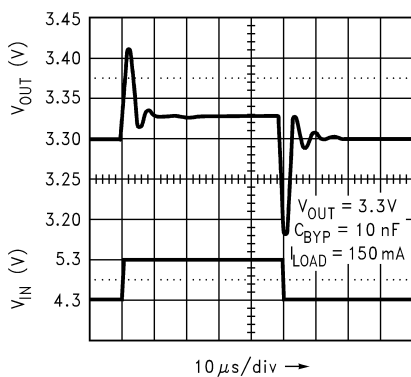

20029438

Turn-On Time

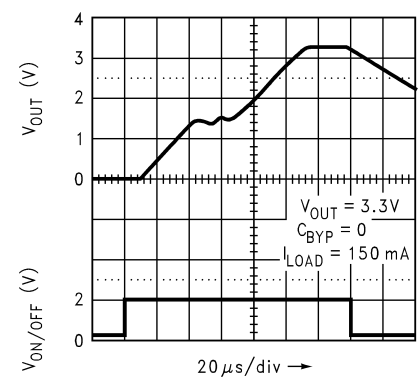

20029439

Typical Performance Characteristics Unless otherwise specified: $C_{IN} = 1\mu F$, $C_{OUT} = 4.7\mu F$, $V_{IN} = V_{OUT(NOM)} + 1$, $T_A = 25^\circ C$, ON/OFF pin is tied to V_{IN} . (Continued)

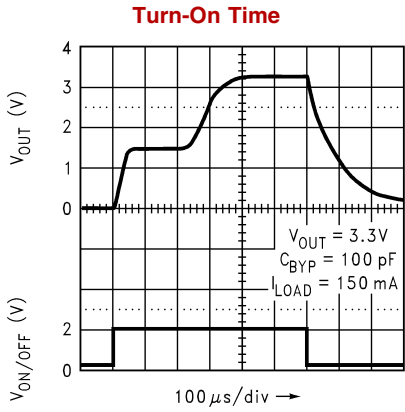

20029440

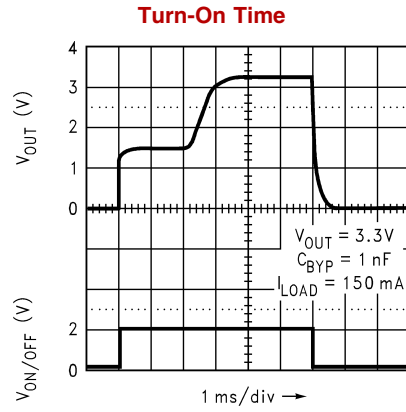

20029441

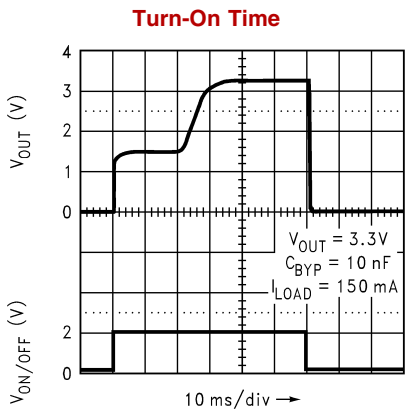

20029442

Application Hints

EXTERNAL CAPACITORS

Like any low-dropout regulator, the LP2992 requires external capacitors for regulator stability. These capacitors must be correctly selected for good performance.

Input Capacitor

An input capacitor whose capacitance is $\geq 1 \mu\text{F}$ is required between the LP2992 input and ground (the amount of capacitance may be increased without limit).

This capacitor must be located a distance of not more than 1 cm from the input pin and returned to a clean analog ground. Any good quality ceramic, tantalum, or film capacitor may be used at the input.

Important: Tantalum capacitors can suffer catastrophic failure due to surge current when connected to a low-impedance source of power (like a battery or very large capacitor). If a Tantalum capacitor is used at the input, it must be guaranteed by the manufacturer to have a surge current rating sufficient for the application.

There are no requirements for ESR on the input capacitor, but tolerance and temperature coefficient must be considered when selecting the capacitor to ensure the capacitance will be $\geq 1 \mu\text{F}$ over the entire operating temperature range.

Output Capacitor:

The LP2992 is designed specifically to work with ceramic output capacitors, utilizing circuitry which allows the regulator to be stable across the entire range of output current with an output capacitor whose ESR is as low as $5 \text{ m}\Omega$. It may also be possible to use Tantalum or film capacitors at the output, but these are not as attractive for reasons of size and cost (see next section Capacitor Characteristics).

The output capacitor must meet the requirement for minimum amount of capacitance and also have an ESR (equivalent series resistance) value which is within the stable range. Curves are provided which show the stable ESR range as a function of load current (see ESR graph below).

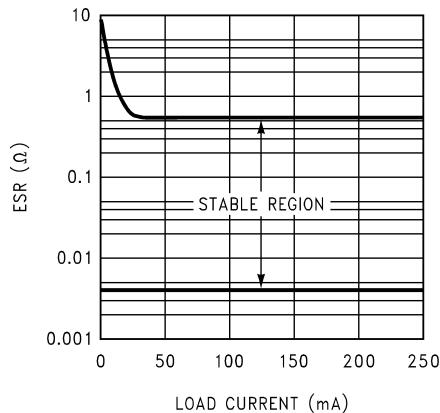

20029407

Important: The output capacitor must maintain its ESR within the stable region over the full operating temperature range of the application to assure stability.

The LP2992 requires a minimum of $4.7 \mu\text{F}$ on the output (output capacitor size can be increased without limit).

It is important to remember that capacitor tolerance and variation with temperature must be taken into consideration when selecting an output capacitor so that the minimum required amount of output capacitance is provided over the full operating temperature range. It should be noted that

ceramic capacitors can exhibit large changes in capacitance with temperature (see next section, *Capacitor Characteristics*).

The output capacitor must be located not more than 1 cm from the output pin and returned to a clean analog ground.

Noise Bypass Capacitor:

Connecting a 10 nF capacitor to the Bypass pin significantly reduces noise on the regulator output. It should be noted that the capacitor is connected directly to a high-impedance circuit in the bandgap reference.

Because this circuit has only a few microamperes flowing in it, any significant loading on this node will cause a change in the regulated output voltage. For this reason, DC leakage current through the noise bypass capacitor must never exceed 100 nA , and should be kept as low as possible for best output voltage accuracy.

The types of capacitors best suited for the noise bypass capacitor are ceramic and film. High-quality ceramic capacitors with either NPO or COG dielectric typically have very low leakage. 10 nF polypropylene and polycarbonate film capacitors are available in small surface-mount packages and typically have extremely low leakage current.

CAPACITOR CHARACTERISTICS

The LP2992 was designed to work with ceramic capacitors on the output to take advantage of the benefits they offer: for capacitance values in the $2.2 \mu\text{F}$ to $10 \mu\text{F}$ range, ceramics are the least expensive and also have the lowest ESR values (which makes them best for eliminating high-frequency noise). The ESR of a typical $4.7 \mu\text{F}$ ceramic capacitor is in the range of $5 \text{ m}\Omega$ to $10 \text{ m}\Omega$, which easily meets the ESR limits required for stability by the LP2992.

One disadvantage of ceramic capacitors is that their capacitance can vary with temperature. Most large value ceramic capacitors ($\geq 2.2 \mu\text{F}$) are manufactured with the Z5U or Y5V temperature characteristic, which results in the capacitance dropping by more than 50% as the temperature goes from 25°C to 85°C .

This could cause problems if a $4.7 \mu\text{F}$ capacitor were used on the output since it will drop down to approximately $2.3 \mu\text{F}$ at high ambient temperatures (which could cause the LP2992 to oscillate). If Z5U or Y5V capacitors are used on the output, a minimum capacitance value of $10 \mu\text{F}$ must be observed.

A better choice for temperature coefficient in ceramic capacitors is X7R, which holds the capacitance within $\pm 15\%$. Unfortunately, the larger values of capacitance are not offered by all manufacturers in the X7R dielectric.

Tantalum:

Tantalum capacitors are less desirable than ceramics for use as output capacitors because they are more expensive when comparing equivalent capacitance and voltage ratings in the $1 \mu\text{F}$ to $4.7 \mu\text{F}$ range.

Another important consideration is that Tantalum capacitors have higher ESR values than equivalent size ceramics. This means that while it may be possible to find a Tantalum capacitor with an ESR value within the stable range, it would have to be larger in capacitance (which means bigger and more costly) than a ceramic capacitor with the same ESR value.

Application Hints (Continued)

It should also be noted that the ESR of a typical Tantalum will increase about 2:1 as the temperature goes from 25°C down to -40°C, so some guard band must be allowed.

ON/OFF INPUT OPERATION

The LP2992 is shut off by driving the ON/OFF input low, and turned on by pulling it high. If this feature is not to be used, the ON/OFF input should be tied to V_{IN} to keep the regulator output on at all times.

To assure proper operation, the signal source used to drive the ON/OFF input must be able to swing above and below the specified turn-on/turn-off voltage thresholds listed in the Electrical Characteristics section under $V_{ON/OFF}$. To prevent mis-operation, the turn-on (and turn-off) voltage signals applied to the ON/OFF input must have a slew rate which is ≥ 40 mV/ μ s.

Caution: the regulator output voltage can not be guaranteed if a slow-moving AC (or DC) signal is applied that is in the range between the specified turn-on and turn-off voltages listed under the electrical specification $V_{ON/OFF}$ (see Electrical Characteristics).

REVERSE INPUT-OUTPUT VOLTAGE

The PNP power transistor used as the pass element in the LP2992 has an inherent diode connected between the regulator output and input. During normal operation (where the input voltage is higher than the output) this diode is reverse-biased.

However, if the output is pulled above the input, this diode will turn ON and current will flow into the regulator output. In such cases, a parasitic SCR can latch which will allow a high current to flow into V_{IN} (and out the ground pin), which can damage the part.

In any application where the output may be pulled above the input, an external Schottky diode must be connected from V_{IN} to V_{OUT} (cathode on V_{IN} , anode on V_{OUT}), to limit the reverse voltage across the LP2992 to 0.3V (see Absolute Maximum Ratings).

LLP MOUNTING

The LLP package requires specific mounting techniques which are detailed in National Semiconductor Application Note # 1187. Referring to the section **PCB Design Recommendations**, it should be noted that the pad style which should be used with the LLP package is the NSMD (non-solder mask defined) type.

Physical Dimensions inches (millimeters)

unless otherwise noted

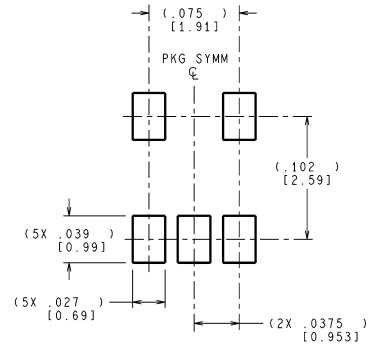
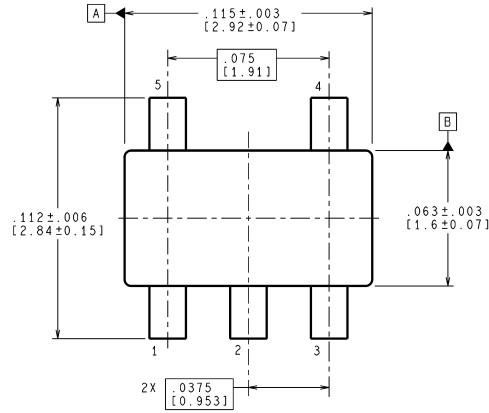

LAND PATTERN RECOMMENDATION

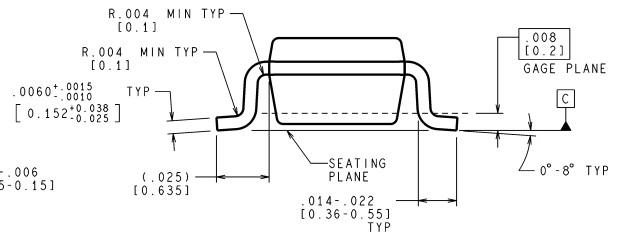
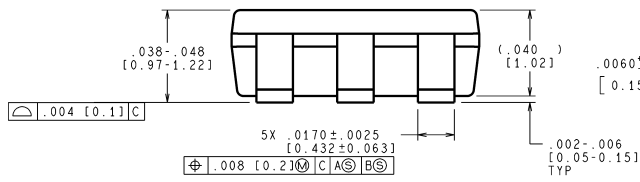

CONTROLLING DIMENSION IS INCH
VALUES IN [] ARE MILLIMETERS

MF05A (Rev B)

5-Lead Small Outline Package (M5)

NS Package Number MF05A

For Order Numbers, refer to *Table 1* in the "Ordering Information" section of this document.

Physical Dimensions inches (millimeters) unless otherwise noted (Continued)

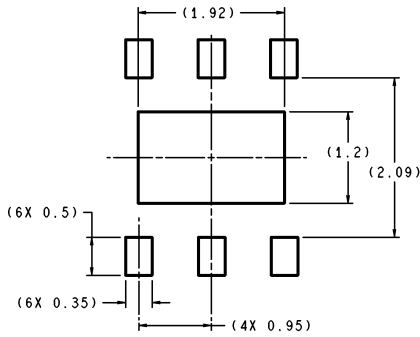

DIMENSIONS ARE IN MILLIMETERS

RECOMMENDED LAND PATTERN
1:1 RATIO WITH PKG SOLDER PADS

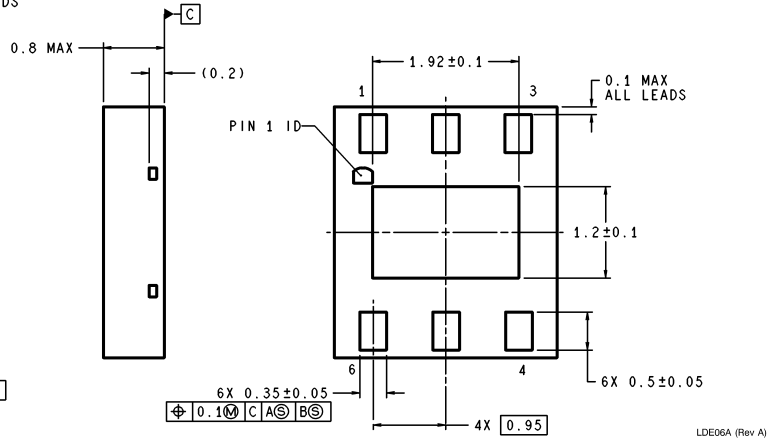
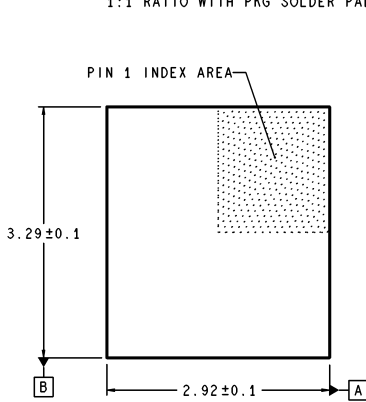

**6-Lead LLP Package (LD)
NS Package Number LDE06A**

LDE06A (Rev A)

National does not assume any responsibility for use of any circuitry described, no circuit patent licenses are implied and National reserves the right at any time without notice to change said circuitry and specifications.

For the most current product information visit us at www.national.com.

LIFE SUPPORT POLICY

NATIONAL'S PRODUCTS ARE NOT AUTHORIZED FOR USE AS CRITICAL COMPONENTS IN LIFE SUPPORT DEVICES OR SYSTEMS WITHOUT THE EXPRESS WRITTEN APPROVAL OF THE PRESIDENT AND GENERAL COUNSEL OF NATIONAL SEMICONDUCTOR CORPORATION. As used herein:

1. Life support devices or systems are devices or systems which, (a) are intended for surgical implant into the body, or (b) support or sustain life, and whose failure to perform when properly used in accordance with instructions for use provided in the labeling, can be reasonably expected to result in a significant injury to the user.
2. A critical component is any component of a life support device or system whose failure to perform can be reasonably expected to cause the failure of the life support device or system, or to affect its safety or effectiveness.

BANNED SUBSTANCE COMPLIANCE

National Semiconductor manufactures products and uses packing materials that meet the provisions of the Customer Products Stewardship Specification (CSP-9-111C2) and the Banned Substances and Materials of Interest Specification (CSP-9-111S2) and contain no "Banned Substances" as defined in CSP-9-111S2.

Leadfree products are RoHS compliant.



National Semiconductor
Americas Customer
Support Center
Email: new.feedback@nsc.com
Tel: 1-800-272-9959

National Semiconductor
Europe Customer Support Center
Fax: +49 (0) 180-530 85 86
Email: europe.support@nsc.com
Deutsch Tel: +49 (0) 69 9508 6208
English Tel: +44 (0) 870 24 0 2171
Français Tel: +33 (0) 1 41 91 8790

National Semiconductor
Asia Pacific Customer
Support Center
Email: ap.support@nsc.com

National Semiconductor
Japan Customer Support Center
Fax: 81-3-5639-7507
Email: jpn.feedback@nsc.com
Tel: 81-3-5639-7560